

HD CCTV Total Solution

IR Bullet Camera User Manual



Please use this camera with a DVR which supports HD video recording.
Please read the instructions thoroughly before using the product.



CAUTION

RISK OF ELECTRIC SHOCK



CAUTION:

To reduce the risk of electric shock, do not expose this apparatus to rain or moisture.

Only operate this apparatus from the type of power source indicated on the label.

The company shall not be liable for any damages arising out of any improper use, even if we have been advised of the possibility of such damages.



The lightning flash with arrowhead symbol, within an equilateral triangle, is intended to alert the user to the presence of uninsulated "dangerous voltage" within the product's enclosure that may be of sufficient magnitude to constitute a risk of electric shock to persons.



This exclamation point within an equilateral triangle is intended to alert the user to the presence of important operating and maintenance (servicing) instructions in the literature accompanying the appliance.



ROHS Announcement

All lead-free products offered by the company comply with the requirements of the European law on the Restriction of Hazardous Substances (RoHS) directive, which means our manufacture processes and products are strictly "lead-free" and without the hazardous substances cited in the directive.



The crossed-out wheeled bin mark symbolizes that within the European Union the product must be collected separately at the product end-of-life. This applies to your product and any peripherals marked with this symbol. Do not dispose of these products as unsorted municipal waste.



CE Mark

This apparatus is manufactured to comply with the radio interference.

The company does not warrant that this manual will be uninterrupted or error-free. We reserve the right to revise or remove any content in this manual at any time.

FEATURES

1. 1/2.7" CMOS Sensor
2. 1080P video output
3. Low light sensitivity of 0.1 Lux / F1.8, 0Lux (IR LED ON)
4. PWM supported to manually control the brightness of the IR LEDs
5. Day and night 24-hour surveillance with IR effective distance up to 25 meters
6. IP66 for weather-proof application
7. Camera parameters adjustable when used with HD CCTV DVR

PACKAGE CONTENT

- IR camera
- User manual
- Installation sticker
- Accessory
- Sun shield

DIMENSIONS*

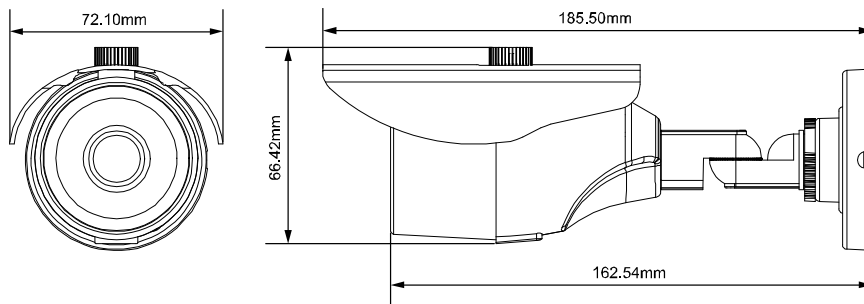

*Dimensional Tolerance: ± 5mm

SPECIFICATIONS*

Pick-up Element	1/ 2.7" CMOS image sensor
Number of Pixels	1930(H) x 1088(V)
Video Frame Rate	1080P@30fps / 1080P@25fps
Min. Illumination	0.1 Lux / F1.8, 0 Lux (IR LED ON)
S/N Ratio	More than 48dB (AGC OFF)
Shutter Speed	1/30 (1/25) sec ~ 1/720000 (1/600000) sec
Lens	f3.6mm / F1.8
Lens Angle	96° (Horizontal) / 50° (Vertical) / 116° (Diagonal)
IR LED	2 units
IR Effective Distance	Up to 25 meters
IR Shift	YES
Day & Night Mode	YES
IRIS Mode	AES
White Balance	AUTO / USER / PUSH / 8000K / 6000K / 4200K / 3200K
AGC	Adjustable
Sharpness	Adjustable
Flickerless	50HZ / 60HZ / OFF
BLC	Adjustable
PWM	YES
IP Rating	IP66
Operating Temperature	-20°C ~ 40°C
Operating Humidity	90% or less relative humidity
Power Source (±10%)	DC12V / 0.5A
Current Consumption (±10%)	150mA (IR LED OFF); 365mA (IR LED ON)
Net Weight (kg)	0.36

* The specifications are subject to change without notice.

INSTALLATION

Step 1: Find the supplied installation sticker, and paste it to where you want to install.
Then, screw holes as marked on the sticker for installation later.

Step 2: Loosen the screw as indicated below to move down the camera lens.
Then, fasten the camera to the ceiling or wall.

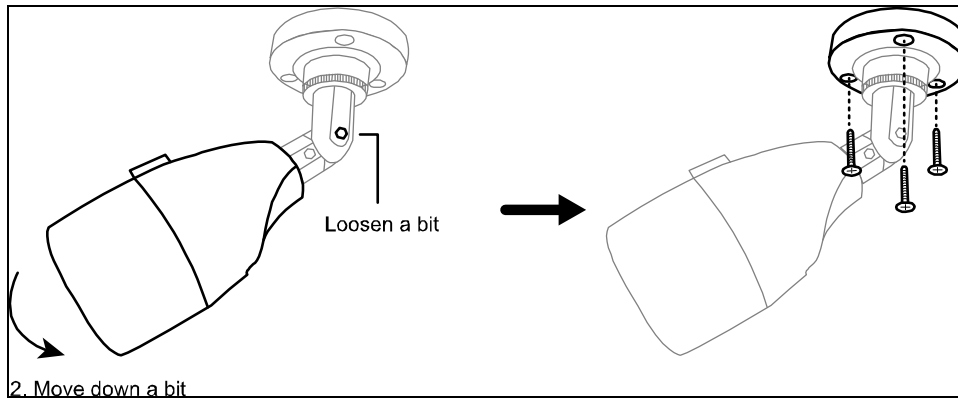

Step 3: Adjust the viewing angle of the camera as indicated below.

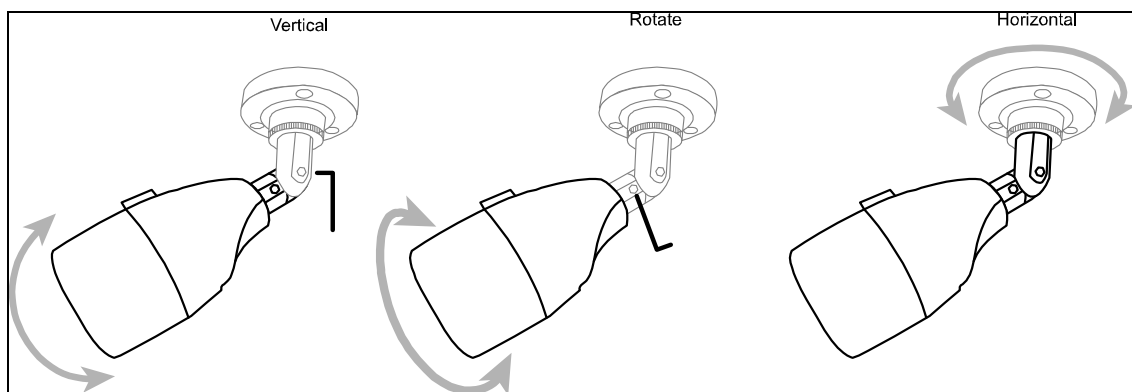

Step 4: Slide the sun shield to the camera, and fasten it with the supplied screw.

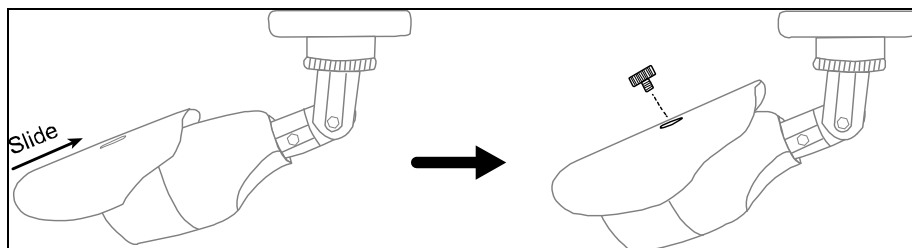

Step 5: Power on the camera and fine-tune the viewing angle.

CONNECTION

1. DC12V Input Terminal

Connect the power terminal of the camera to a DC 12V regulated power supply.

Note: Please use the correct power adaptor, DC12V (regulated), to operate this unit. The power tolerance of this unit is DC12V \pm 10%. Over maximum DC 12V power input will damage this unit.

2. Video Output Connector (VIDEO OUT)

Connect the camera video output to the video input of a DVR with 75 Ω coaxial cable.

Note: To ensure the camera has sufficient protection against moisture, an extra waterproof measure, such as by using an insulating tape, must be used to cover the power and video connectors after connection.

IR LED BRIGHTNESS CONTROL (PWM)

This function is used to control the brightness of IR LEDs. The brightness is set to the maximum by default.

Note: This function shows only on our brand's HD CCTV DVR with specific firmware version. If you don't see this option, try upgrading your DVR or check with your installer.

For example, if you feel the image is too bright when the night mode is on, resulting a little bit overexposure, you can use this function to modify as you wish.

On the DVR live view, right click to show the DVR main menu, and select **ADVANCED CONFIG** → **DCCS** → **DCCS MENU**.

ADVANCED CONFIG				
CAMERA	CH1	CH2	CH3	CH4
DETECTION	OSD MENU		SETUP	
ALERT	DCCS MENU		SETUP	
NETWORK				
DISPLAY				
RECORD	F.W.		E8	
DCCS	DEVICE		AVT SERIES	
NOTIFY	CONNECTION		OK	
EXIT				

In **DCCS SETUP**, click the value to change it from **0** ~ **100**.

DCCS SETUP	
IR1 BRIGHTNESS USER	100

CAMERA PARAMETERS

This camera series has its own configuration menu, and either of the two methods below is available to access the menu based on the camera model you have.

Note: The methods below are available only when the camera is used with our brand's HD CCTV DVR.

■ **Method 1**

On the DVR live view, click the channel which connects this camera to display in the full screen mode, and select .

■ **Method 2**

On the DVR live view, right click to show the DVR main menu, and select **ADVANCED CONFIG** → **DCCS** → **OSD MENU**. Select the channel which connects this camera, and click **SETUP** to enter the menu of camera parameters.

ADVANCED CONFIG				
CAMERA	CH1	CH2	CH3	CH4
DETECTION	OSD MENU		SETUP	
ALERT	DCCS MENU		SETUP	
NETWORK	F.W.		E8	
DISPLAY	DEVICE		AVT SERIES	
RECORD	CONNECTION		OK	
DCCS				
NOTIFY				
EXIT				

When the camera menu is entered, you'll see the keys on the bottom right corner to move between and change those configurations.



Move between selections.



Change settings.





Call the camera parameters menu or enter the currently-selected item.

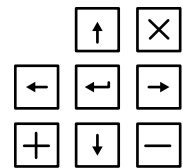

Quit the camera parameters mode.



MENU			DESCRIPTION
DAY / NIGHT	MODE	EXT	Use the external light sensor we added in the camera to detect the surrounding light condition and switch to color or B/W mode. If you're not satisfying with the mode switch time, you can go to D TO N / N TO D to manually adjust the sensitivity.
		COLOR	Always keep the day and night mode to day mode.
		B&W	Always keep the day and night mode to night mode.
		AUTO	No function.
	D TO N	1 ~ 63	Set the sensitivity for the day & night mode from day to night. The higher the value, the more sensitivity the mode is switched when the light condition is changed. Note: This function is not available when AUTO and COLOR is selected.
	N TO D	1 ~ 63	Set the sensitivity for the day & night mode from night to day. The higher the value, the more sensitivity the mode is switched when the light condition is changed. Note: This function is not available when AUTO and COLOR is selected.
	DELAY TIME	1 ~ 60	Set the delay time in second after which the day and night switch is made. This is used for the environment where the light condition may change suddenly and usually last for a short time, for example, the entrance of a parking lot. It may cause the day & night mode switching constantly and damage the camera. With this function, the camera will delay the mode switch at night since the light change is temporary and unnecessary to pay attention.
AWB	MODE	AUTO	Automatically adjust the white balance based on the surrounding environment.
		USER	Manually adjust the white balance parameters. Choose USER , and click  (ENTER) to enter the USER MODE to modify R / G / B gain parameters.
		(PUSH)	It's used for the environment surrounded largely by a particular color, such as blue, causing color confusion. Aim the camera to a white place, and select (PUSH) to memory this white. Then, aim the camera to where it's supposed to face.
		HOLD	It's used to force the camera memorizing the current white balance setting and remain the same even when the environment is changed.
		8000K / 6000K / 4200K / 3200K	Switch to the suitable color temperature based on the current environment to get the right color. 8000K = Shade; 6000K = Cloud; 4200K = White fluorescent; 3200K = Halogen light bulb.
		R-G GAIN	Adjust the red-green value from 1 ~ 255.
		B-G GAIN	Adjust the blue-green value from 1 ~ 255
AE (automatic exposure)	MODE	ESC	Not available for this model.
		HOLD	Not available for this model.
		DC	Not available for this model.
	BRIGHT	0 ~ 255	Set the level of brightness to adjust the brightness of the image. The more the value, the brighter the image.
	SHUTTER	AUTO	Automatically adjust the shutter speed for exposure based on the current environment.

MENU		DESCRIPTION	
AE (automatic exposure)		1/25 1/30 1/50 1/60 1/100 1/120 1/250 1/500 1/1000 1/3000 1/10000	
	FLICKER	OFF / 50HZ / 60HZ	
	BLC	0 ~ 16	
	AGC	1 ~ 5	
	LSC	ON / OFF	
SPECIAL	PRIVACY ZONE	AREA SEL.	
		MASK PAT.	
		SX	
		EX	
		SY	
		EY	
	MOTION*	MOTION	
		SENSITI.	
		ALARM	
		HOLD TIME	
	HLC	HLC	
		MASK VALUE	
		THRESHOLD	
			Manually choose the shutter speed you need for exposure.
			Enable this function to fix the flicker situation.
		Adjust the image to compensate for an area that is overpowered by brightness because of excessive light. The image will be properly exposed for clearness. Note: This function is available only in the day mode.	
		Set the level of Auto Gain Control to detect and enhance the image signals when the light condition is poor. The higher the value, the stronger the signals will be enhanced, and the more noise the image will get.	
		Enable or disable Lens Shading Correction to correct the phenomenon of vignetting when the focal length is short.	
		Select AREA1 or AREA2 to show a predefined area for masking. To move and change the area, please go to SX / EX / SY / EY.	
		Select the color to mask: black / gray / white. Select OFF to disable area masking.	
		Extend / narrow the current area from the left side.	
		Extend / narrow the current area from the right side.	
		Extend / narrow the current area from the top.	
		Extend / narrow the current area from the bottom.	
		Enable (ON) / disable (OFF) motion detection.	
		Set the sensitivity to trigger motion detection. The higher the value, the more sensitive the camera to trigger motion detection.	
		Choose the way to show motion detection is triggered: TRACE to frame the area in red which motion trigger occurs on the screen, or ICON to simply show a running man icon for motion trigger occurrences.	
		Set how long the alarm lasts in second from 1 to 10.	
		HLC (high light compensation) is used to suppress strong backlight for clearer images. A grey mask will be covered on the source of the strong light. Choose ON and click  (ENTER) to select the areas for this function. The screen will be divided into 16 areas. Move to the area you want, and click  (ENTER) to make X to O .	
		Set the darkness of the mask. The more the value, the lighter the grey you'll get. The less the value, the darker the grey you'll get.	
		Set the level of light source which enables masking. The more the value, the stronger the light source will trigger HLC; the less the value, the lighter the light source will trigger HLC.	

MENU			DESCRIPTION
EFFECT	COLOR GAIN	0 ~ 255	Set the level of color saturation. The more the value, the more saturated the color will be, but the more noise the image will get.
	COLOR HUE	0 ~ 71	Set the level of hue.
	SHARPNESS	0 ~ 255	Set the level of sharpness to enhance the clarity of image detail by adjusting the aperture and sharpening the edges. The more the value, the sharper the image will be.
	CONTRAST	0 ~ 255	Set the level of contrast. The more the value, the more the contrast level of the image will be.
	BRIGHT OFF.	-128 ~ 127	Set the level to compensate the brightness of the image if needed. The more the value, the brighter the image will be.
	MIRROR	OFF / ON	Enable to turn the images horizontally based on your installation situation when necessary.
	FLIP	OFF / ON	Enable to flip the image 180° when necessary.
SYSTEM	CAMERA ID	0 ~ 255	Set the camera ID.
	ID DISP.	OFF / ON	Enable or disable the display of the camera ID.
	NAME DISP.	OFF / ON	This function has no use.
	LANGUAGE	ENG / 中文	Select the language of the menu: English / Simplified Chinese.
	FACTORY INIT	OFF / ON	Enable to restore the camera parameters to factory default values. The camera image will flash once when the reset is done.
EXIT	SAVE & EXIT	--	Save all the changes you've made in each menu and exit.
	EXIT	--	Exit without saving.